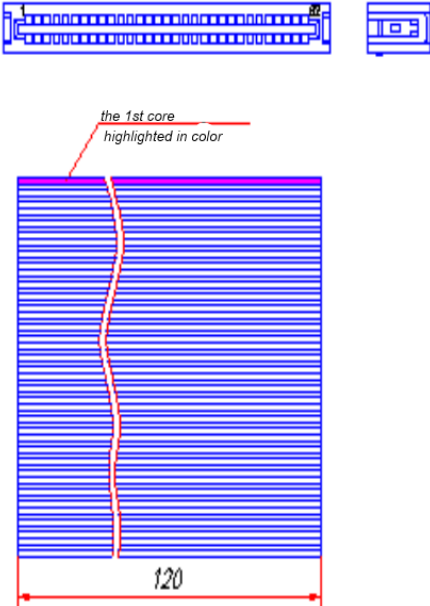

## Fastwel Accessories ACSxxxxx

Reference list  
Version 1.7

| Order number | Description  | External view | Note   |
|--------------|--|---------------|--|
| ACS00000     | Cable IDC-n – IDC-n, where n – number of contacts depending on the ordering number.<br><br>Connectors with the 2,54 mm pitch of contacts are used, two rows. |               | Cable length L=600 mm; Number of contacts n=10                       |
| ACS00001     |  |               | Cable length L=600 mm; Number of contacts n =20                      |
| ACS00002     |  |               | Cable length L=600 mm; Количество контактов Number of contacts n =26 |
| ACS00002-01  |  |               | Cable length L=1500 mm; Number of contacts n=26                      |
| ACS00003     |  |               | Cable length L=600 mm; Number of contacts n=34                       |
| ACS00004     |  |               | Cable length L=600 mm; Number of contacts n=40                       |

| Order number | Description   | External view | Note                   |
|--------------|---|---------------|------------------------|
| ACS00005     | Cable IDC-10 – D-SUB 9M (socket, two rows, no enclosure).   |               | Cable length L=1800 mm |
| ACS00005-01  | Used: IDC connector, 10 contacts, pitch of 2,54 mm, two rows.   |               | Cable length L=180 mm  |
| ACS00006     | Cable IDC-10 – D-SUB 9F (sockets, two rows, no enclosure).<br><br>Used: IDC connector, 10 contacts, pitch of 2,54 mm, two rows. |               | Cable length L=1800 mm |

| Order number | Description      | External view  | Note   |
|--------------|------------------|--|--|
| ACS00007     | Installation kit |  | <p>Socket to the flat ribbon cable<br/>PFEC-62-VK-0-G - 2 pcs.; Flat<br/>ribbon cable p/n 2-57040-2 AMP<br/>– 120 mm</p> |

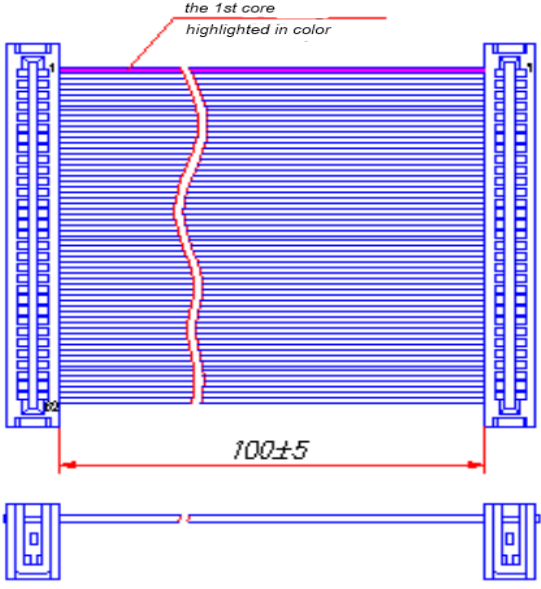
| Order number | Description   | External view  | Note                  |
|--------------|---|--|-----------------------|
| ACS00007-01  | Cable with two sockets PFEC-62-VK-0-G (Aptos Technology). |  | Cable length L=100 mm |

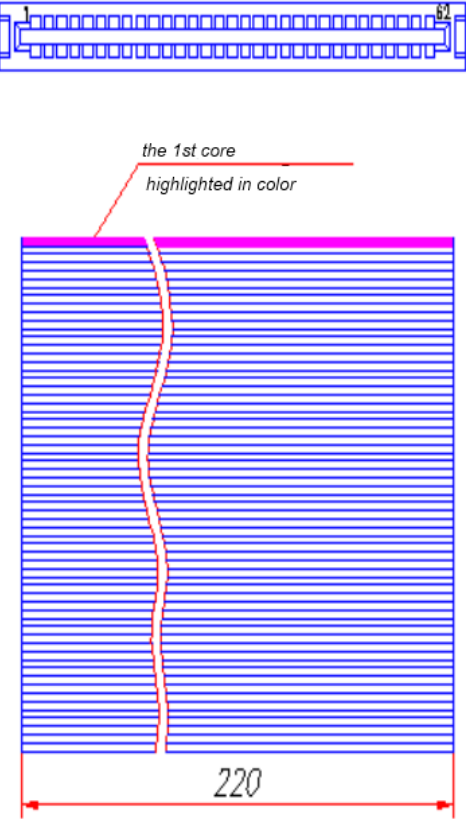
| Order number | Description      | External view   | Note   |
|--------------|------------------|---|--|
| ACS00008     | Installation kit |  | <p>Socket to the flat ribbon cable<br/>           PFEC-62-VK-0-G - 3 pcs; Flat<br/>           ribbon cable p/n 2-57040-2 AMP<br/>           – 0.22 m</p> |

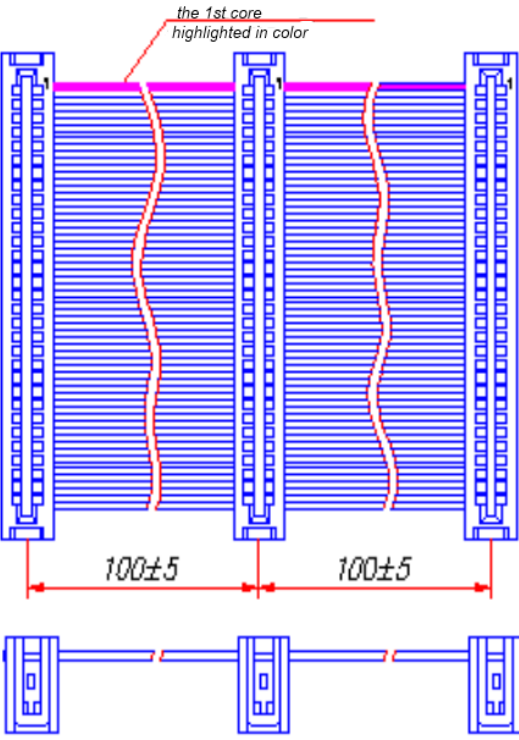

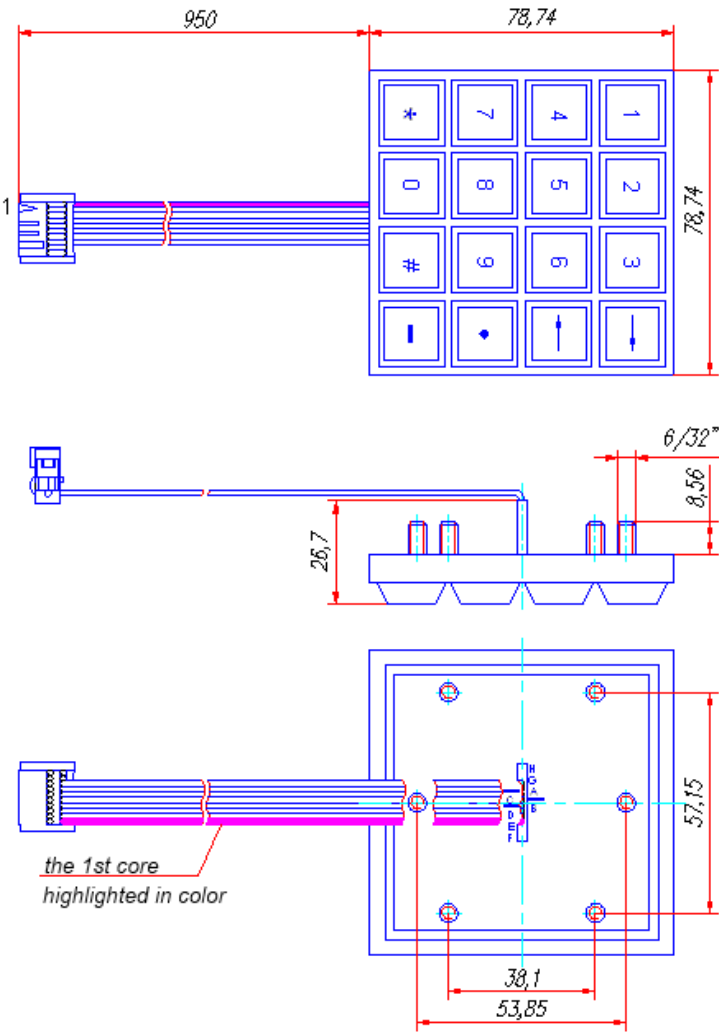
| Order number | Description   | External view   | Note                   |
|--------------|---|---|------------------------|
| ACS00008-01  | Cable with three crimped sockets PFEC-62-VK-0-G (Aptos Technology). |  | Cable length L=200 mm. |

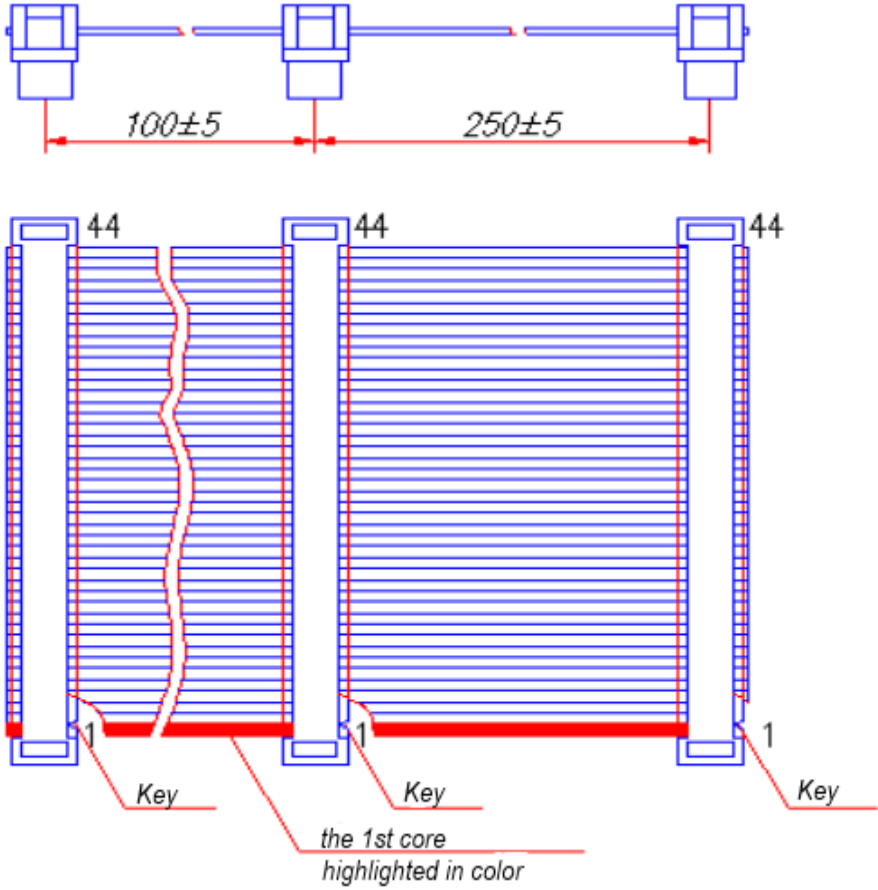
| Order number | Description  | External view  | Note   |
|--------------|--|--|--|
| ACS00009     | <p>Keyboard FK-3.</p> <p>Used: IDC connector, 10 contacts, pitch of 2.54 mm, two rows.</p> |  <p>The drawing consists of three views of the keyboard:         <ul style="list-style-type: none"> <li><b>External view:</b> Shows the keyboard's layout with a 4x4 grid of keys. The keys are labeled: Row 1: *, 7, 4, 1; Row 2: 0, 8, 5, 2; Row 3: #, 9, 6, 3; Row 4: -, ., ←, →. Dimensions: total width 950, keyboard width 78,74, and keyboard height 78,74.</li> <li><b>Side view:</b> Shows the keyboard's profile. Dimensions: connector height 6/32", key height 8,56, and keyboard thickness 25,7.</li> <li><b>Top view:</b> Shows the keyboard's footprint. Dimensions: connector width 38,1, keyboard width 53,85, and keyboard height 57,15. A note indicates 'the 1st core highlighted in color' with a red line pointing to the first core in the connector area.</li> </ul> </p> | <p>16-keys dust- and moisture-proof Matrix Keyboard 4x4 (GRAYHILL)</p> |

| Order number | Description   | External view   | Note                   |
|--------------|---|---|------------------------|
| ACS00010     | <p>Cable with three crimped connectors IDC2-44.</p> <p>Used: IDC2 connectors, 44 contacts, pitch of 2.0 mm, two rows.</p> |  | Cable length L=350 mm. |

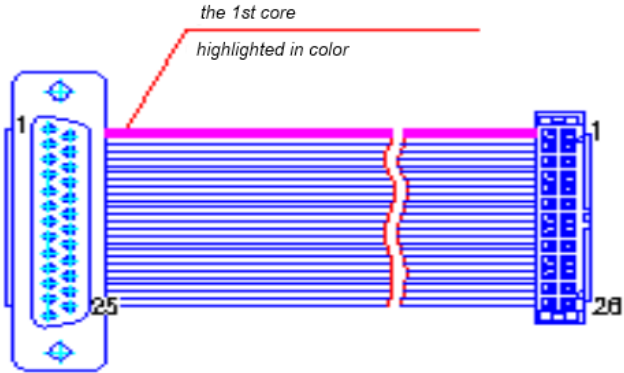
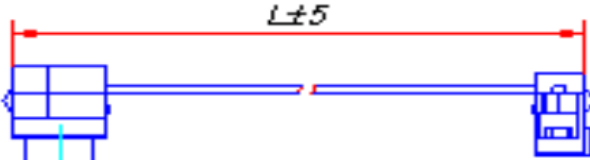
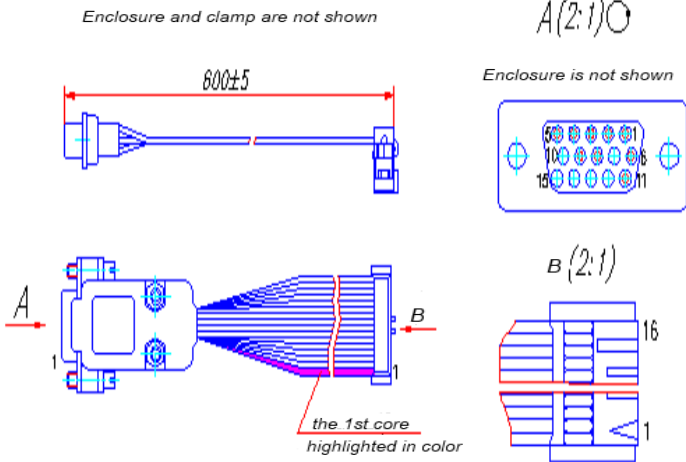

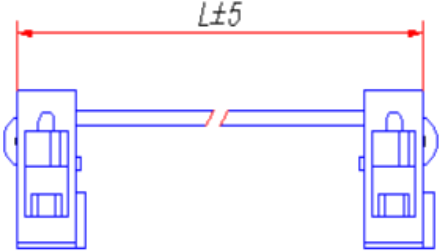
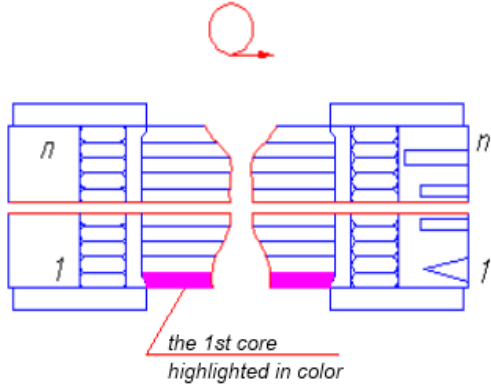
| Order number | Description  | External view  | Note                   |
|--------------|--|--|------------------------|
| ACS00011     | Cable IDC-26 – D-SUB 25F<br>(socket, two rows, without an enclosure).<br>Used: IDC connector, 26 contacts, pitch of 2.54 mm, two rows. | <br> | Cable length L=600 mm. |
| ACS00011-01  |  |  | Cable length L=200 mm. |
| ACS00011-02  |  |  | Cable length L=100 mm. |
| ACS00012     | Cable IDC-16 – D-SUB 15F<br>(socket, 3 rows, in the enclosure).<br>Used: IDC connectors, 16 contacts, pitch of 2,54 mm, two rows.      |   | Cable length L=600 mm. |

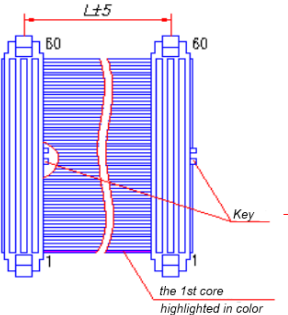
| Order number | Description   | External view  | Note   |
|--------------|---|--|--|
| ACS00013     |   |    | Cable length L=600 mm; Number of contacts n=14 |
| ACS00014     | <p>Cable IDC-n – IDC-n, where n – number of contacts depending on the ordering number.</p> <p>Used: IDC connectors with a contact pitch of 2.54 mm, two rows.</p> |    | Cable length L=600 mm; Number of contacts n=16 |
| ACS00015     | High-density cable with two crimped connectors.   |    | Cable length L=300 mm.                         |
| ACS00015-02  | Used: connectors with 60 contacts, pitch of 1.27 mm, two rows. Cable length depends on the use.   |  | Cable length L=120 mm.                         |
| ACS00015-03  |   |  | Cable length L=140 mm.                         |

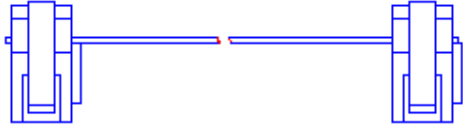
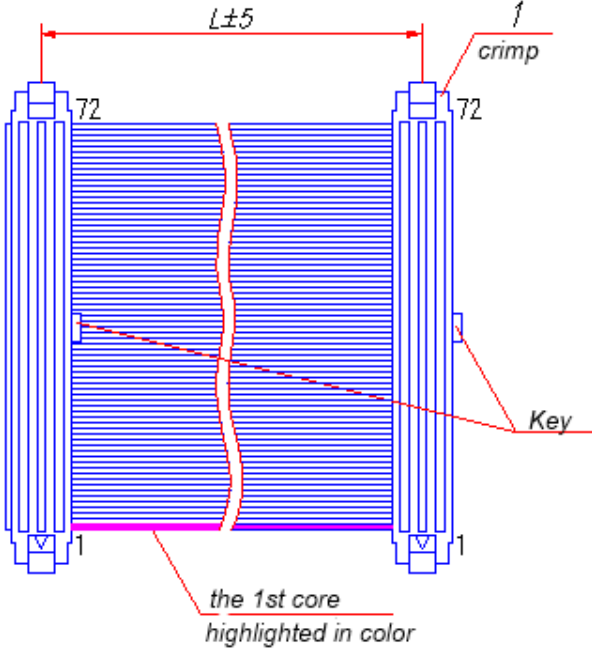
| Order number | Description  | External view   | Note                   |
|--------------|--|---|------------------------|
| ACS00015-04  |  |   | Cable length L=500 mm. |
| ACS00016     |  |   | Cable length L=300 mm. |
| ACS00016-02  | <p>High-density cable with two crimped connectors.</p> <p>Used: connectors with 72 contacts, pitch of 1.27 mm, two rows.</p> |  | Cable length L=120 mm. |
| ACS00016-03  |  |   | Cable length L=140 mm. |
| ACS00016-04  |  |   | Cable length L=500 mm. |

| Order number | Description   | External view                 | Note                    |
|--------------|---|-------------------------------|-------------------------|
| ACS00018     | <p>Cable with three crimped connectors IDC2-44.</p> <p>Used: IDC2 connectors, 44 contacts, pitch of 2.0 mm, two rows.</p> |                               | Cable length L=2000 mm. |
| ACS00019     | Cable USB Mini-B – D-SUB 9F (socket, 2 rows, in the enclosure)  | <p>Enclosure is not shown</p> | Cable length L=1800 mm. |

| Order number | Description   | External view | Note                           |
|--------------|---|---------------|--------------------------------|
| ACS00021     | <p>Power supply cable for Siemens GSM-modems.</p> <p>Used: RJ-12 connector.</p>                                       |               | <p>Cable length L=1000 mm.</p> |
| ACS00022     | <p>Cable with two crimped connectors IDC-40.</p> <p>Used: IDC connectors, 40 contacts, pitch of 1,27mm, two rows.</p> |               | <p>Cable length L=140 mm.</p>  |

| Order number | Description  | External view | Note  |
|--------------|--|---------------|---|
| ACS00023     | Cable IDC2-10 – D-SUB 9M (socket, two rows, in the enclosure).<br>Used: IDC connector, 10 contacts, pitch of 2.0 mm, two rows.<br>Used for connecting peripheral devices to serial port of RS-232 Fastwel modules. |               | Cable length L=150 mm.                      |
| ACS00023-01  |  |               | Cable length L=300 mm.                      |
| ACS00023-02  |  |               | Cable length L=1000 mm                      |
| ACS00023-03  |  |               | Cable length L=500 mm                       |
| ACS00024     | Installation kit<br>The kit contains: IDC2 Samtec connector with a contact pitch of 2.0 mm.  |               | Connector p/n TCSD-10-01<br>Samtec - 1 pcs. |

| Order number | Description  | External view | Note  |
|--------------|--|---------------|---|
| ACS00025     | <p>Installation kit.</p> <p>The kit contains IDC2 Samtec connector with a contact pitch of 2.0 mm.</p>   |               | <p>Connector p/n TCSD-05-01<br/>Samtec – 1 pcs.</p> |
| ACS00026     | Cable “USB-extension”.   |               | Cable length L=1000 mm.                             |
| ACS00026-01  | Used: USB Type A connectors.   |               | Cable length L=1080 mm.                             |
| ACS00027     | <p>Cable IDC2-10 – D-SUB 15F (socket, three rows, in the enclosure.)</p> <p>Used: IDC2 connector, 10 contacts, pitch of 2.0 mm., two rows.</p> |               | Cable length L=120 mm.                              |
| ACS00027-01  | Cable for connecting peripheral devices to RGB analog interface (VGA) of Fastwel modules.  |               | Cable length L=1000 mm.                             |

| Order number | Description   | External view   | Note   |
|--------------|---|---|--|
| ACS00028     | <p>Cable IDC-10 – D-SUB9M (plug).</p> <p>Connectors with contact pitch of 2.54 mm, crimped for the flat ribbon cable.</p> |   | Cable length L=270 mm.   |
| ACS00029     |   | Cable kit: RS-485 adapter, USB connector adapter, LPT adapter, RS-232 adapter, Ethernet cable, VGA adapter. |  |
| ACS00030     |   | Kit which includes: fan, heatsink, a set of stands, screws and washers.                                     |  |
| ACS00031-01  | <p>Installation kit</p> <p>The kit contains a single row plug for the contacts with a pitch of 2.0 mm.</p>                |   | Plug (female) PHR-5 JST - 1 pcs.; Contact SPH-002T-P0.5S JST - 5 pcs. A=11.8 mm. |
| ACS00031-02  |   |   | Plug (female) PHR-6 JST - 1 pcs.; Contact SPH-002T-P0.5S JST - 6 pcs., A=13.8 mm |

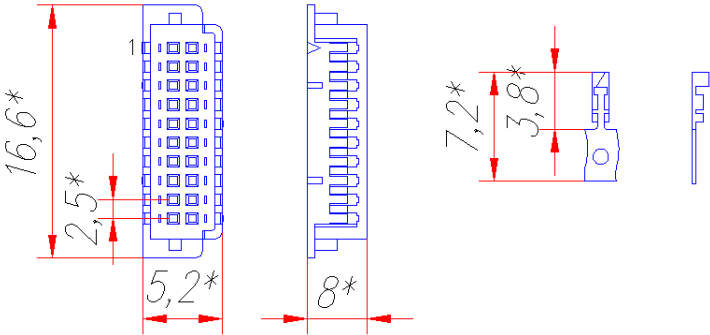

| Order number | Description  | External view   | Note   |
|--------------|--|---|--|
| ACS00031-03  |  |   | Plug (female) PHR-2 JST - 1 pcs.;<br>Contact SPH-002T-P0.5S JST –<br>2 pcs., A=5,8 mm.             |
| ACS00034     |  | Kit contains: heatsink, screws and washers.   |  |
| ACS00035     |  | Kit contains: fan, heatsink, set of stands, screws, washers and thermal grease.   |  |
| ACS00036     |  | Cable kit: Ethernet cable, VGA adapter, POWER adapter cable, USB connector Adapter, cable for connection of HDD SATA, Molex Straight-to-Right Angle Signal Cable Assembly p/n 88762-5400. |  |
| ACS00037     | <p>Installation kit.</p> <p>The kit contains a two-row socket with a contact pitch of 1,25 mm.</p> |    | <p>Plug (female) DF13-20DS-1.25C Hirose - 1 pcs.;</p> <p>Contact DF13-2630SCF Hirose - 20 pcs.</p> |

| Order number | Description  | External view | Note   |
|--------------|--|---------------|--|
| ACS00038     |  |               | Plug (female)<br>AMP 4-171822-4<br>and 4 contacts<br>AMP 170263-1  |
| ACS00038-01  | Installation kit.<br><br>The kit contains a socket for additional power supply connector of Fastwel modules. |               | Cable for feeding the power supply voltage of +5 V, wires HB-0.12 4 600.<br><br>Cable length L=1 m.        |
| ACS00038-02  |  |               | Cable for feeding power supply voltages of +5 V and +12 V, wires HB-0.12 4 600.<br><br>Cable length L=1 m. |

| Order number | Description  | External view | Note   |
|--------------|--|---------------|--|
| ACS00039     | <p>Installation kit.</p> <p>The kit contains a socket for connection to the additional power supply connection of Fastwel modules.</p>   |               | <p>Plug (female) 22-01-2045 Molex - 1 pcs.;</p> <p>Contact p/n 08-50-0113 Molex - 4 pcs.</p> |
| ACS00040-01  | <p>The kit for two-row connectors with a pitch of 2 mm, installed on Fastwel modules.</p> <p>The kit contains IDC2 socket for flat ribbon cable fit for a certain number of positions.</p> |               | <p>Socket, 10 contacts, A=15,1 mm.</p>   |
| ACS00040-02  |  |               | <p>Socket, 16 contacts; A=21.10 mm.</p>  |
| ACS00040-03  |  |               | <p>Socket, 26 contacts; A=31.10 mm.</p>  |
| ACS00040-04  |  |               | <p>Socket, 20 contacts; A=25.10 mm.</p>  |
| ACS00040-05  |  |               | <p>Socket, 44 contacts; A=49.10 mm.</p>  |

| Order number | Description  | External view                     | Note  |
|--------------|--|-----------------------------------|---|
| ACS00041     | <p>Installation kit.</p> <p>The kit contains a single-row plug (female) with a contact pitch of 2.54 mm.</p> |                                   | <p>Plug (female) p/n 1-87499-5 AMP - 1 pcs.<br/>Contact p/n 167021-2 AMP - 9 pcs.</p> |
| ACS00042     |  | Null-modem cable 9(m)-9(m) 1.8 m. |   |
| ACS00043     | Cable for the connection of PS/2 devices to PS/2 interface of Fastwel modules.                               |                                   | Cable length L=200 mm, PS/2 connectors and PHR-6 JST female plug                      |
| ACS00043-01  | Used: PHR-6 female plug or 6 contact socket.<br>Contact pitch of 2.0 mm, single row.                         |                                   | Cable length L=200 mm, PS/2 connectors and Leotronics socket                          |

| Order number | Description  | External view   | Note                             |
|--------------|--|---|----------------------------------|
| ACS20044     |  | ACS20044 kit for installation in MIC584-01 modules of SDDs.                             | The kit contains MIC584 Module   |
| ACS20044-01  |  | ACS20044 kit for installation in MIC584-01 modules of SDDs with moisture-proof coating. |                                  |
| ACS20046     |  | Installation kit for CPC109.  | Used for CPC109 CPU Module       |
| ACS00047     | Kit for the single-row connectors with a pitch of 2 mm, installed in Fastwel modules.<br><br>The kit contains a plug (female) for a certain number of positions, with a contact pitch of 2.0 mm. The contacts are not included.<br><br>For ordering contacts see ACS00049. |   | Plug for 2 positions, A=4,2 mm   |
| ACS00047-01  |  |   | Plug for 3 positions, A=6,2 mm   |
| ACS00047-02  |  |   | Plug for 4 positions, A=8,2 mm   |
| ACS00047-03  |  |   | Plug for 6 positions, A=12,2 mm  |
| ACS00047-04  |  |   | Plug for 10 positions, A=20,2 mm |
| ACS00047-05  |  |   | Plug for 14 positions, A=28,2 mm |

| Order number | Description   | External view | Note  |
|--------------|---|---------------|---|
| ACS00048     |   |               | Plug for 10 positions, A=10,3 mm  |
| ACS00048-01  | Kit for two-row connectors with a pitch of 2 mm, installed on Fastwel modules.  |               | Plug for 16 positions, A=16,3 mm  |
| ACS00048-02  | The kit contains: plug (female) for a certain number of positions, with contact pitch of 2.0 mm. The contacts are not included. |               | Plug for 26 positions, A=26,3 mm  |
| ACS00048-03  |   |               | Plug for 20 positions, A=20,3 mm  |
| ACS00048-04  | For ordering contacts see ACS00049.   |               | Plug for 44 positions, A=44,3 mm  |
| ACS00049     |   |               | Set of contacts, 10 pcs.  |
| ACS00049-01  | Set of contacts for plugs (female sockets) ACS00047 and ACS00048.   |               | Crimped contact for the equipment heatproof wire with fluoroplastic insulation 1x0.14, length of 1 m, 1 pcs.                        |
| ACS00049-02  |   |               | Crimped contact for the equipment heatproof wire with fluoroplastic insulation 1x0.14, length of 1 m, 5 pcs, included into the kit. |

| Order number | Description  | External view | Note  |
|--------------|--|---------------|---|
| ACS00050     |  |               | Cable length L=500 mm.<br>Number of contacts n=10 |
| ACS00050-01  | Cable IDC2-n – IDC2-n, where n – number of contacts depending on the ordering number.  |               | Cable length L=500 mm.<br>Number of contacts n=20 |
| ACS00050-02  | Used: IDC2 connectors, pitch of 2 mm, two rows.  |               | Cable length L=500 mm.<br>Number of contacts n=26 |
| ACS00051     | Cable IDC2-10 – 2xUSBA Socket.<br><br>Used: IDC2 connectors, 10 contacts, pitch of 2.0 mm, two rows; USB Type A, socket;   |               | Cable length L=500 mm.                            |
| ACS00052     | Cable IDC2-26 – BLS-8 + BLD-16.<br><br>Used: IDC2 connectors, 10 contacts, pitch of 2.0 mm., two rows;<br>Single-row cable socket BLS, 8 contacts, pitch of 2,54 mm;<br>Two-row cable socket BLD, 16 contacts, pitch of 2,54 mm; |               | Cable length L=700 mm.                            |

| Order number | Description   | External view | Note  |
|--------------|---|---------------|---|
| ACS00053     | Cable IDC2-n – BLD-n, where n – number of contacts depending on the ordering number.  |               | Cable length L=500 mm.<br>Number of contacts n=20 |
| ACS00053-01  | Used:<br>IDC2 connectors, pitch of 2.0 mm, two rows;<br>Two-row cable socket BLD, pitch of 2,54 mm.;  |               | Cable length L=500 mm.<br>Number of contacts n=26 |
| ACS00054     | Cable PHR-2 – BLS-2.<br><br>Used connectors:<br>PHR (JST, cable socket), 2 contacts, pitch of 2.0 mm, single row;<br>Single-row cable socket BLS, 2 contacts, pitch of 2,54 mm; |               |   |
| ACS00055     |   |               | Cable length L=220 mm.                            |
| ACS00055-01  | Cable RJ-45 – RJ-45.  |               | Cable length L=480 mm.                            |
| ACS00055-02  | Connection diagram 1 to 1.  |               | Cable length L=1000 mm.                           |
| ACS00055-03  |   |               | Cable length L=120 mm.                            |